

6mm EPP Ru

200mm

100mm

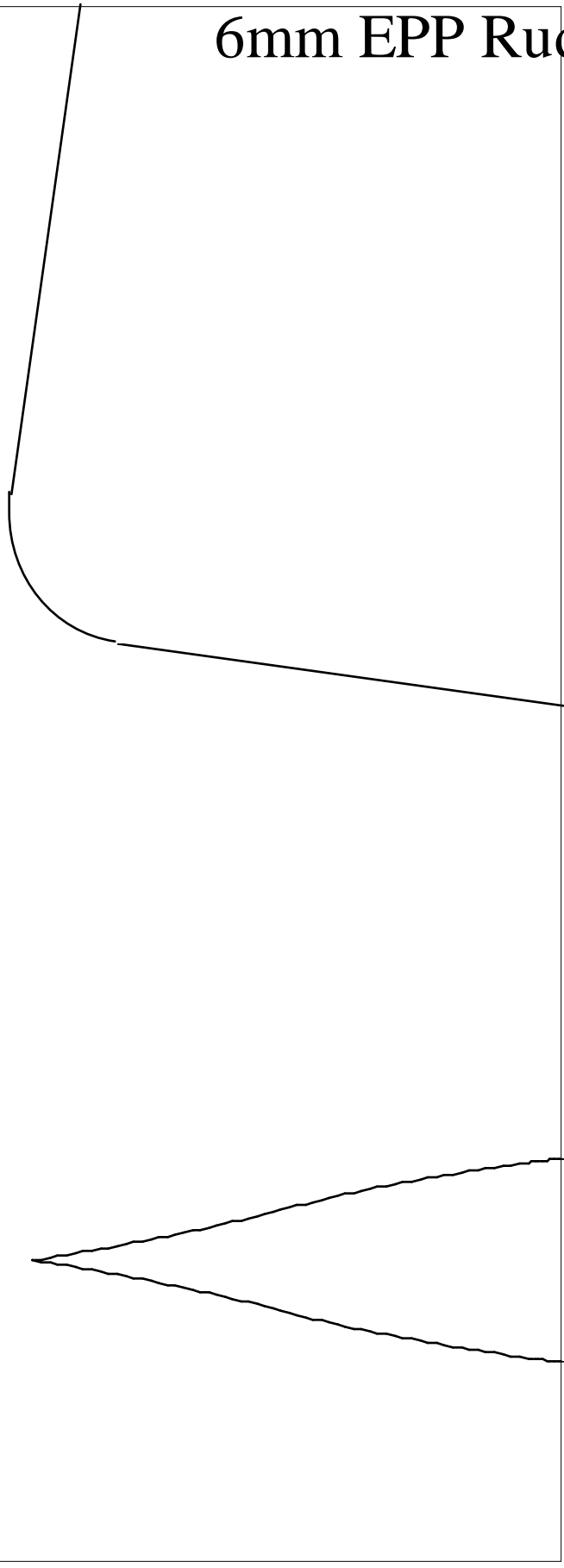

dder

rods
each
side

Bounce
6mm EPP Stab

Bounce
3mm EPP top doubler

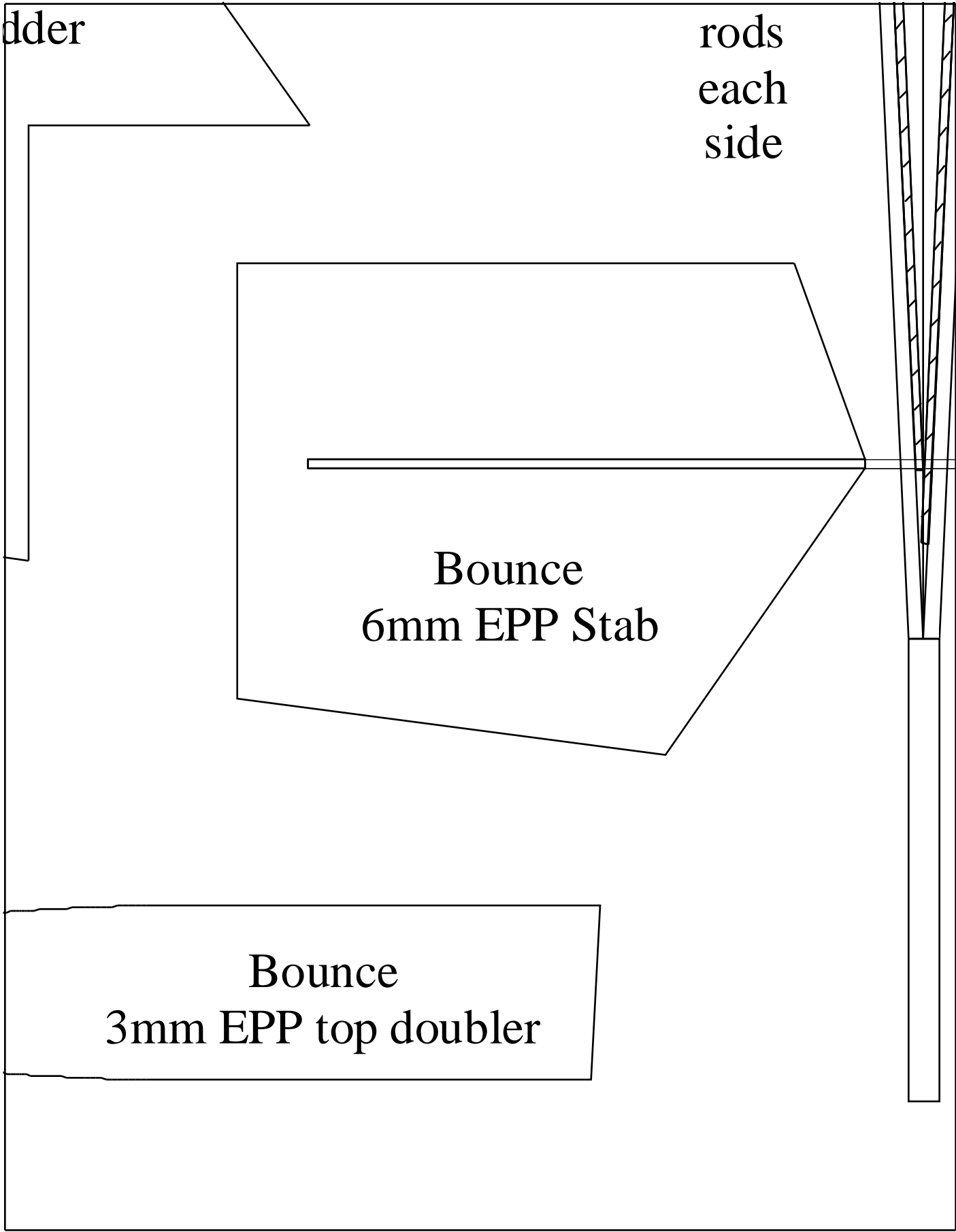

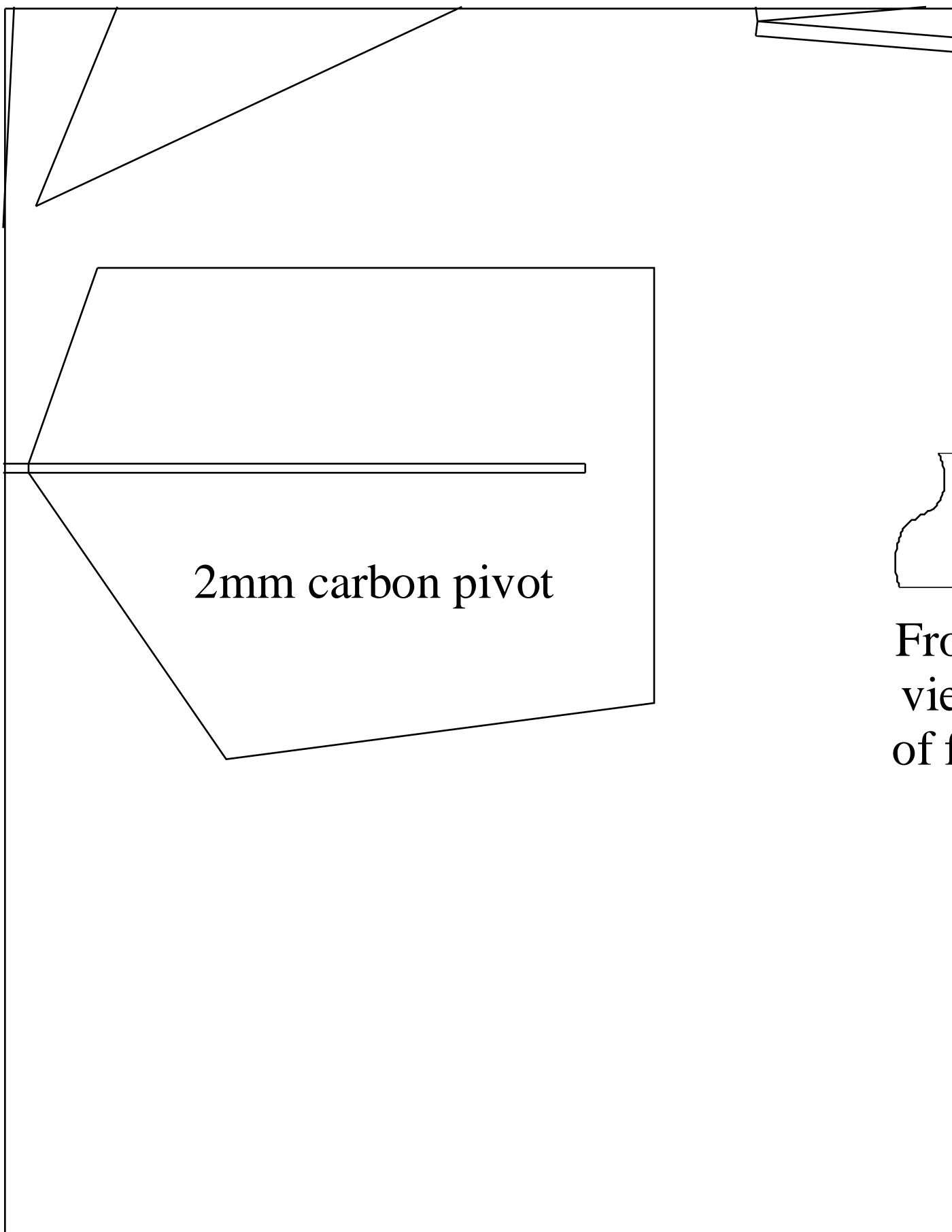

2mm carbon pivot

Front view of f

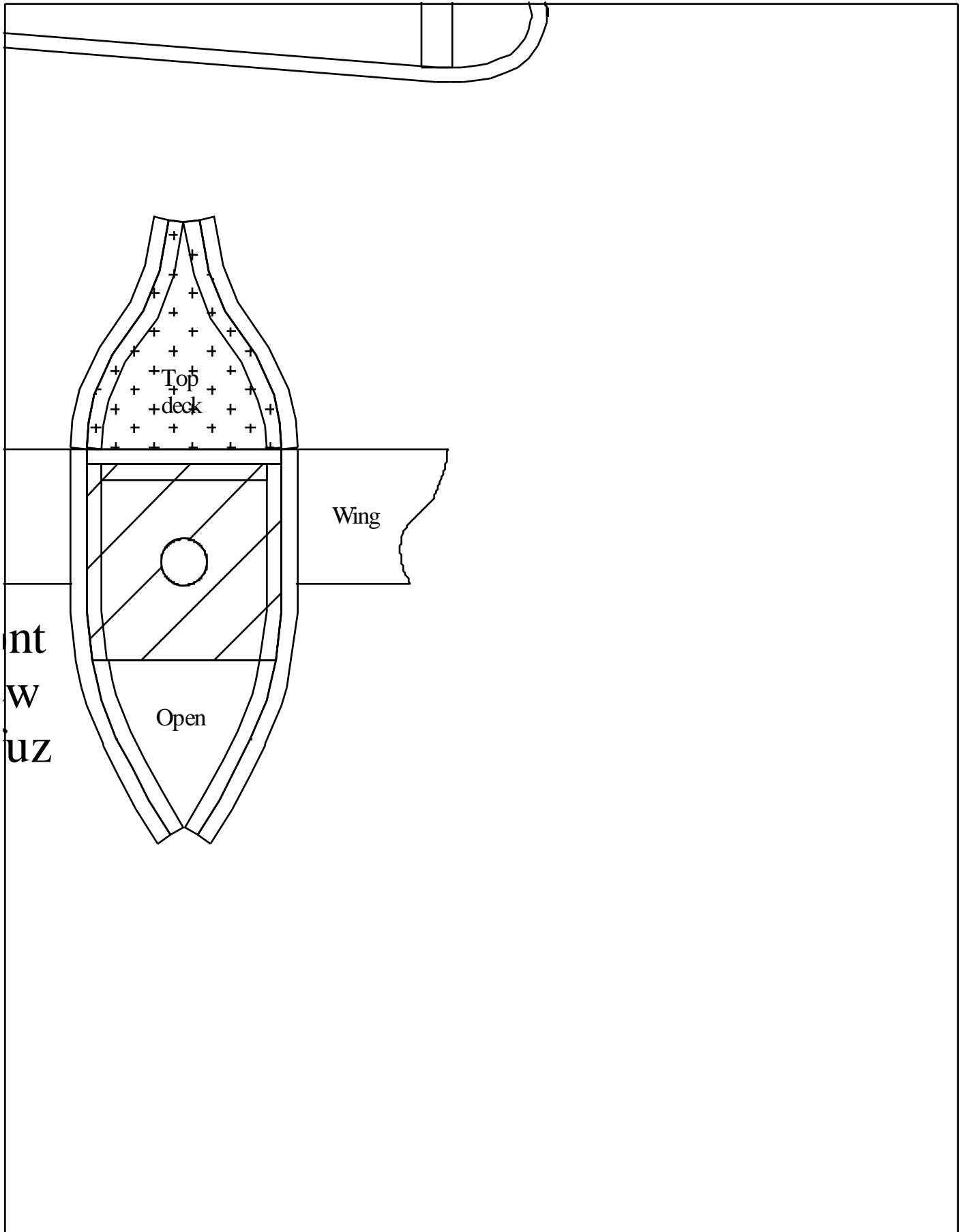

Top
deck

Wing

Open

nt
w
uz

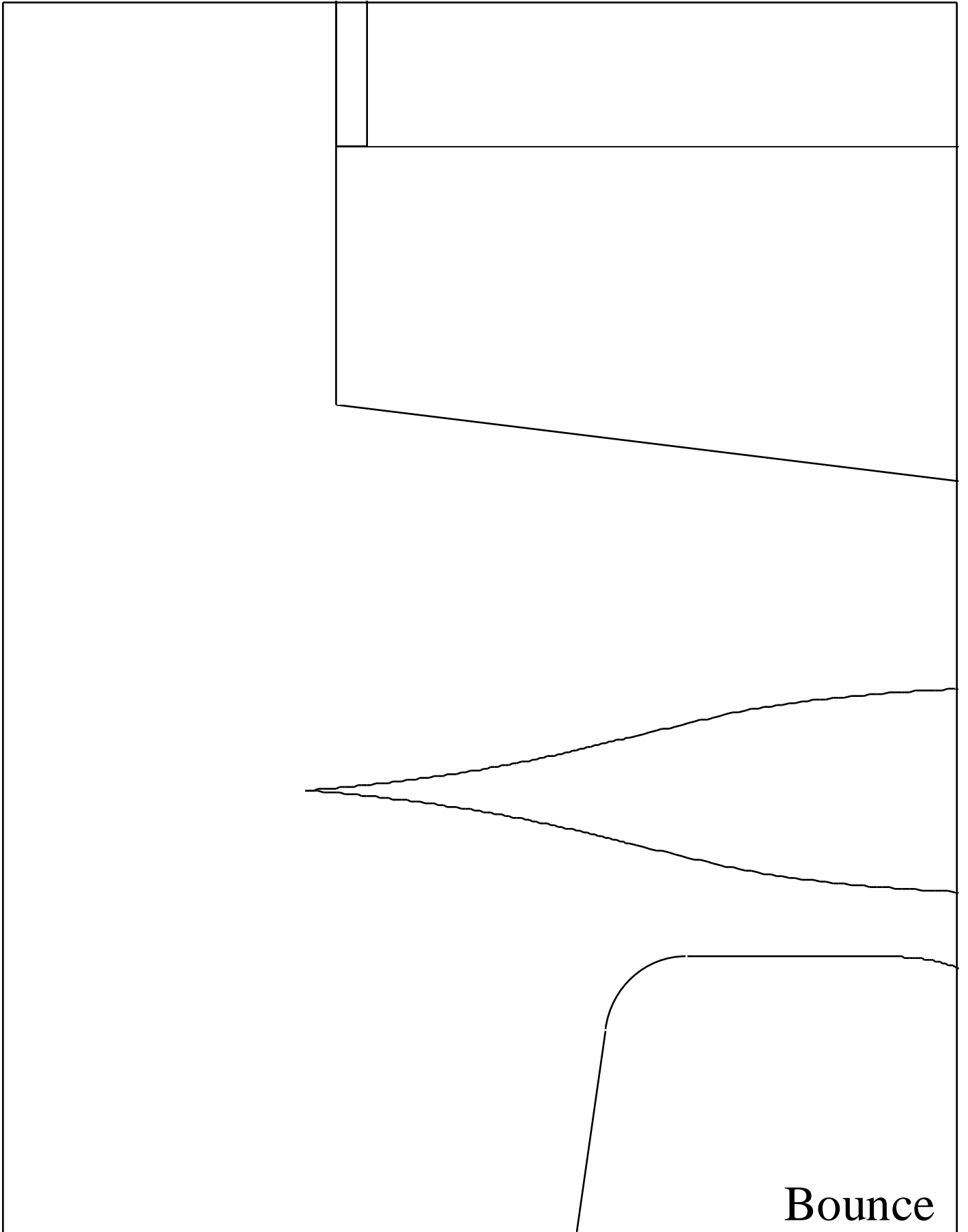

Bounce

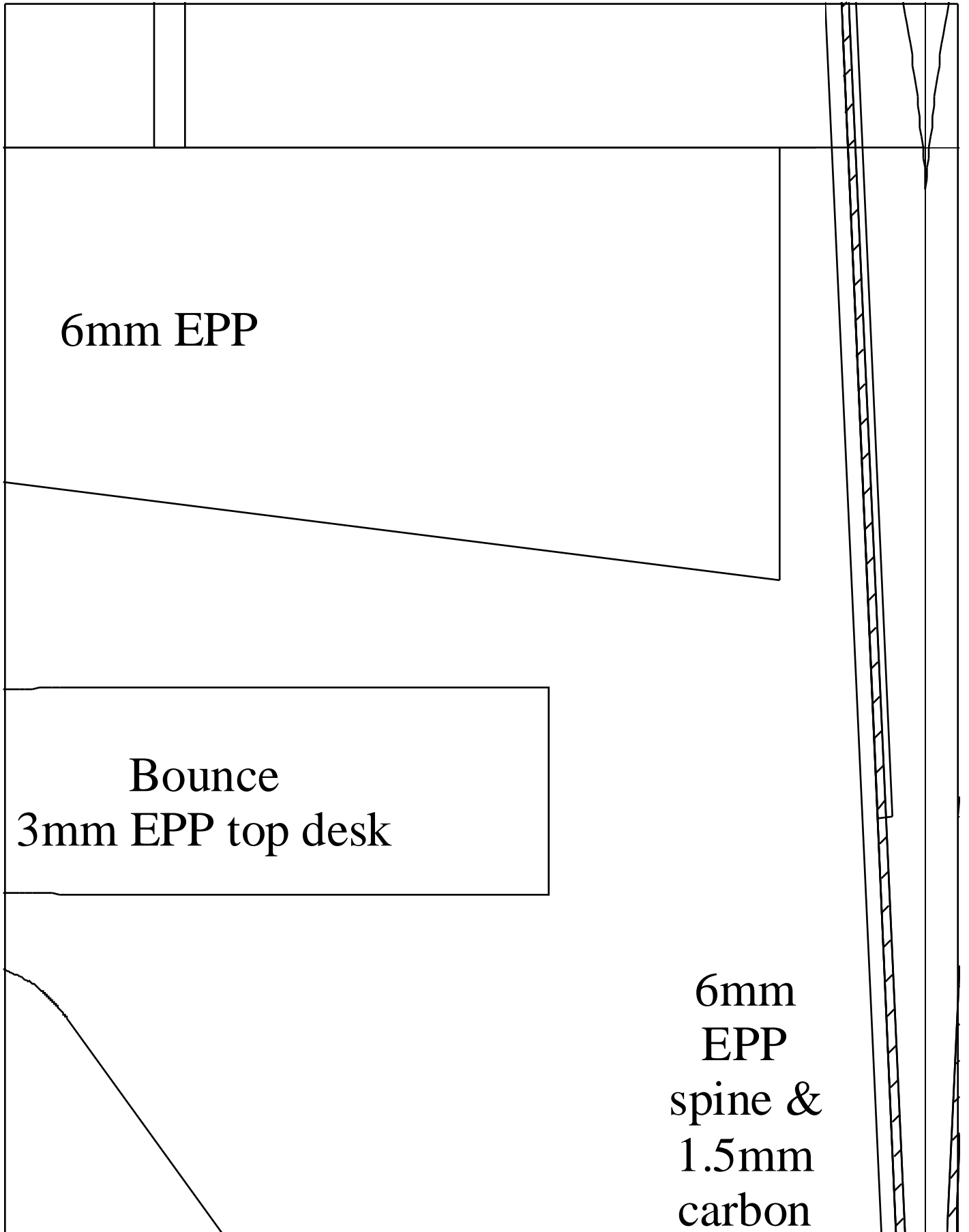

6mm EPP

Bounce
3mm EPP top desk

6mm
EPP
spine &
1.5mm
carbon

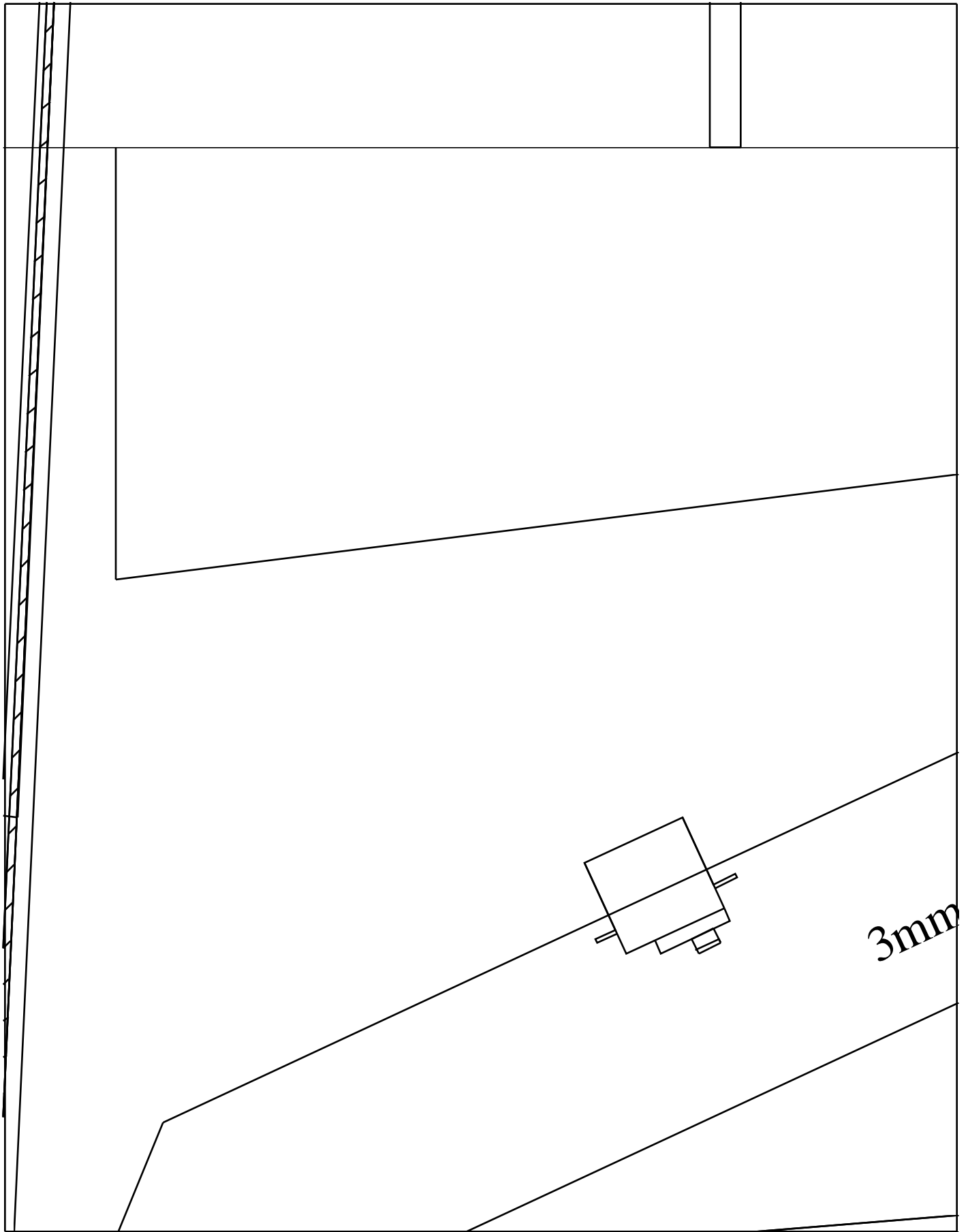

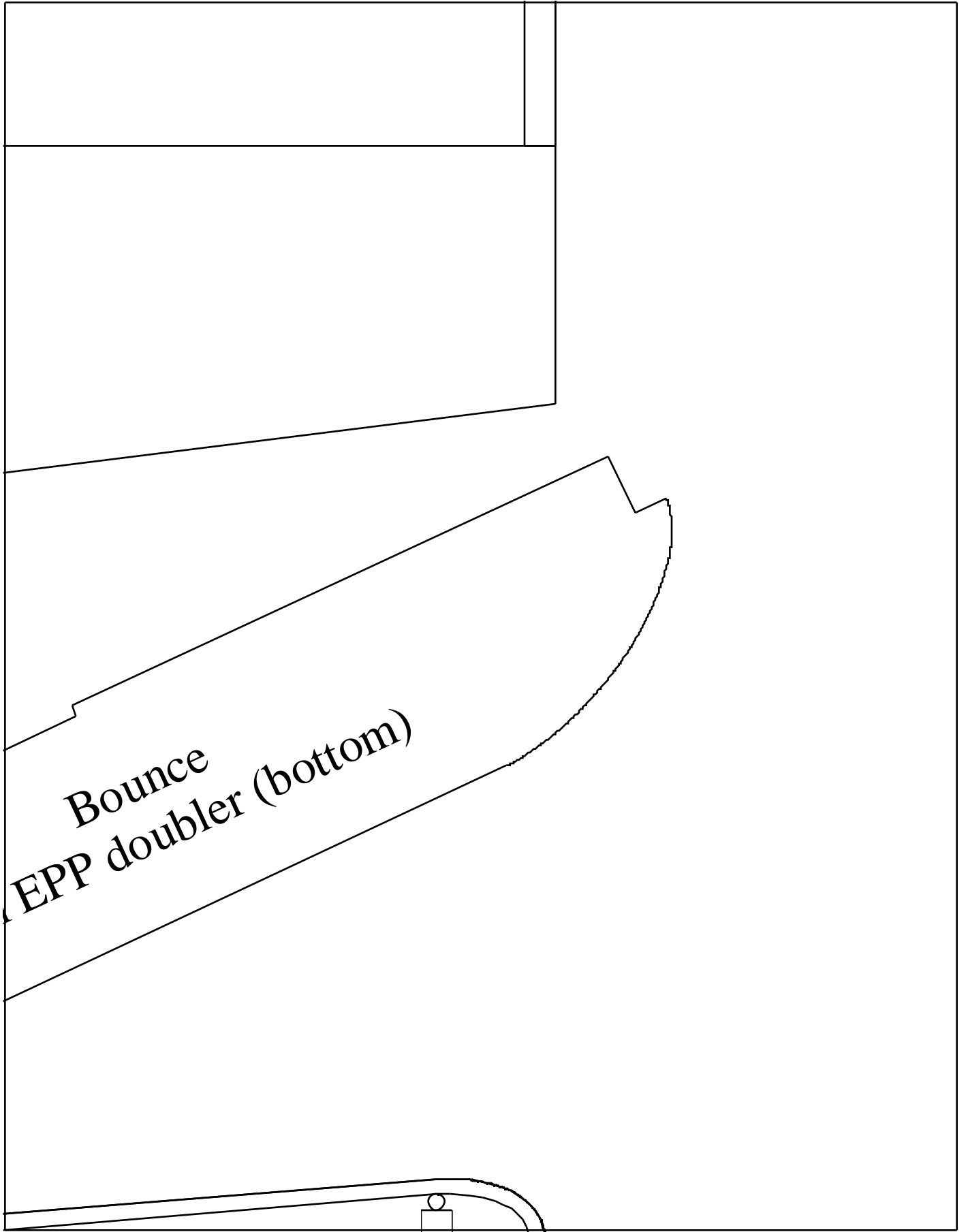

**Bounce
EPP doubler (bottom)**



'Bour
Copyright Da
5-Dec-05 www.flye

3mm EPP wing skin
(300x600mm folded
over ribs)

Horizontal 6mm EPP spine &
1.5 or 2mm carbon both sides

nce' v4b
avid Theunissen
electric.ukgateway.net

CG
30-33%

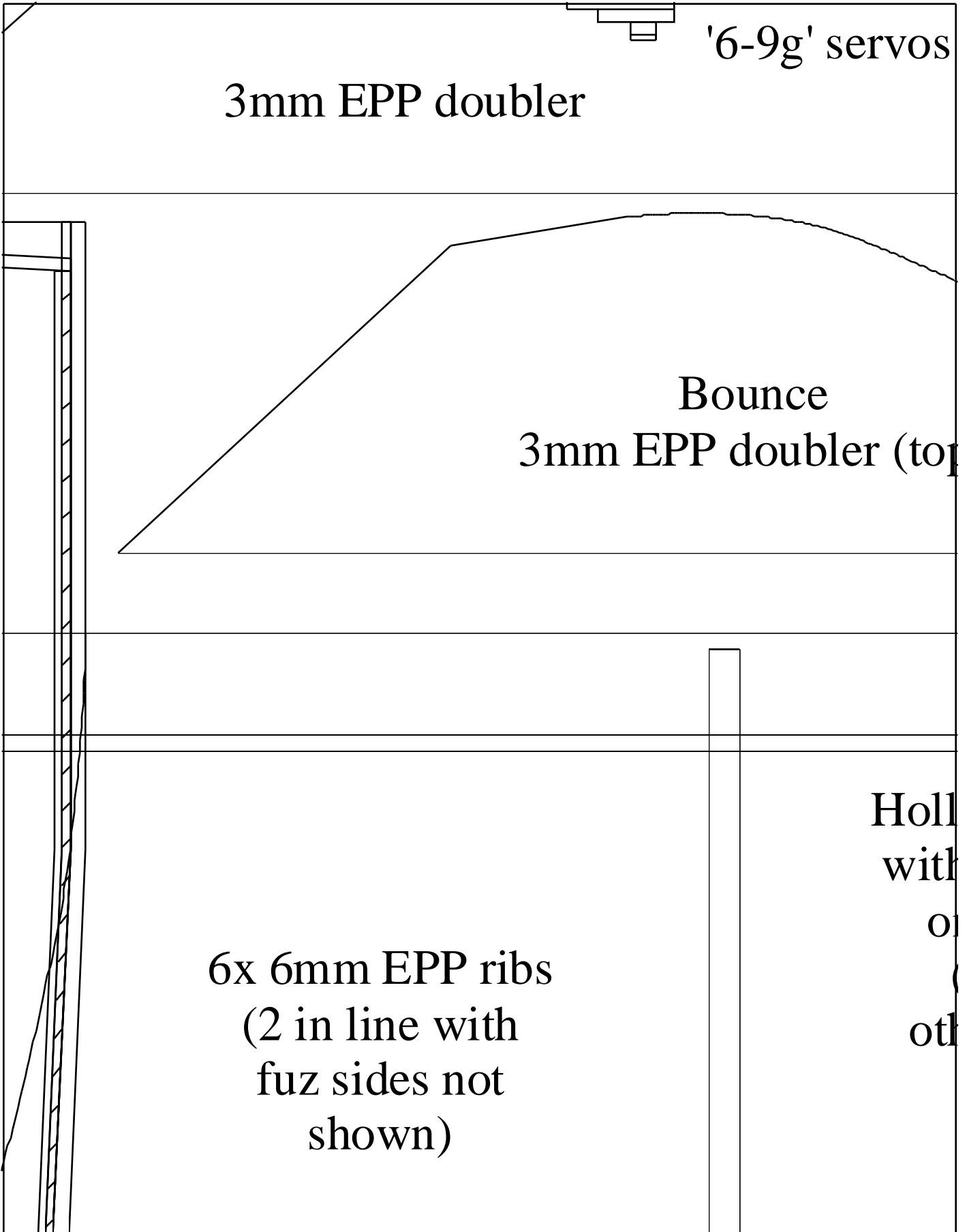

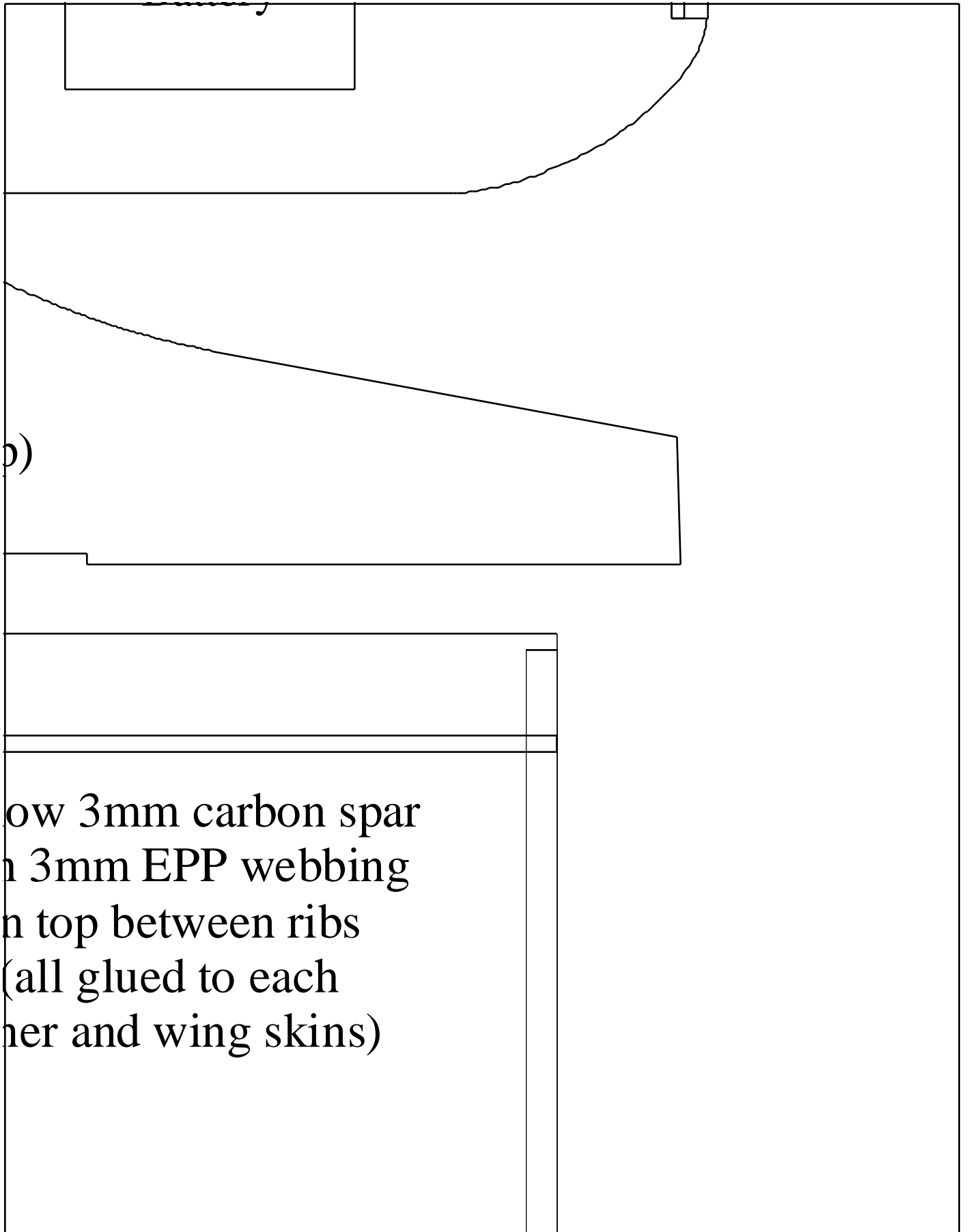

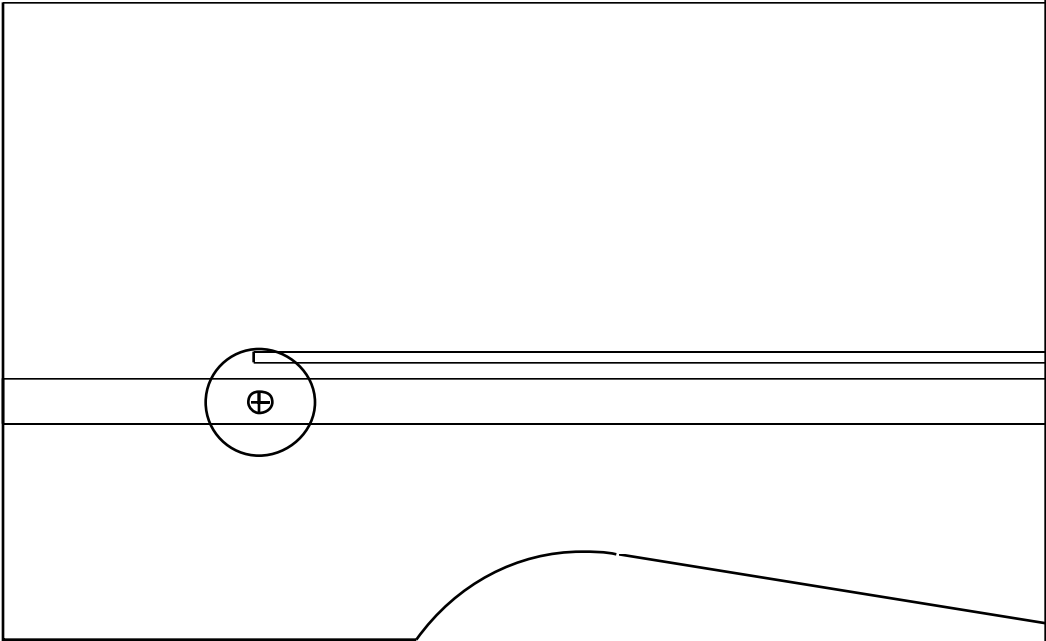

6mm EPP
Rudder &
Stabilisers

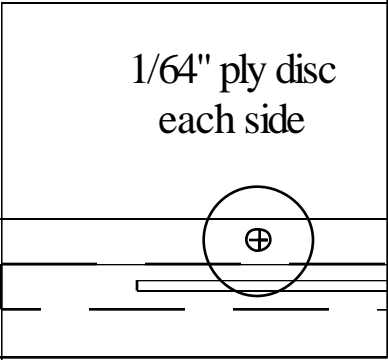

1/64" ply disc
each side

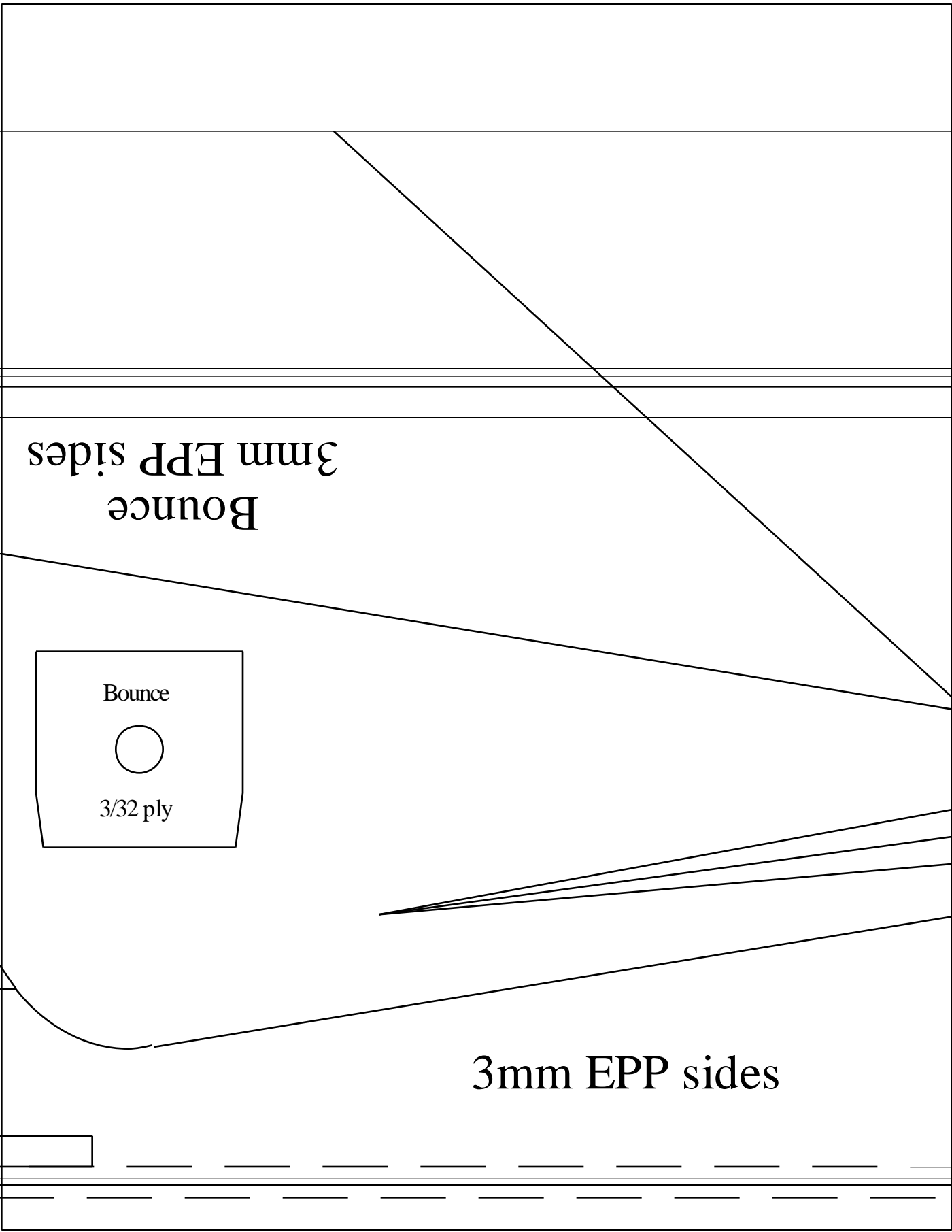

Bounce
3mm EPP sides

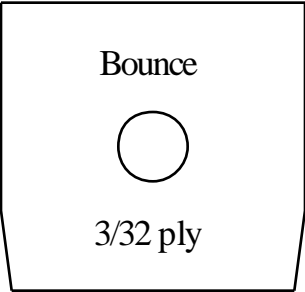

3mm EPP sides



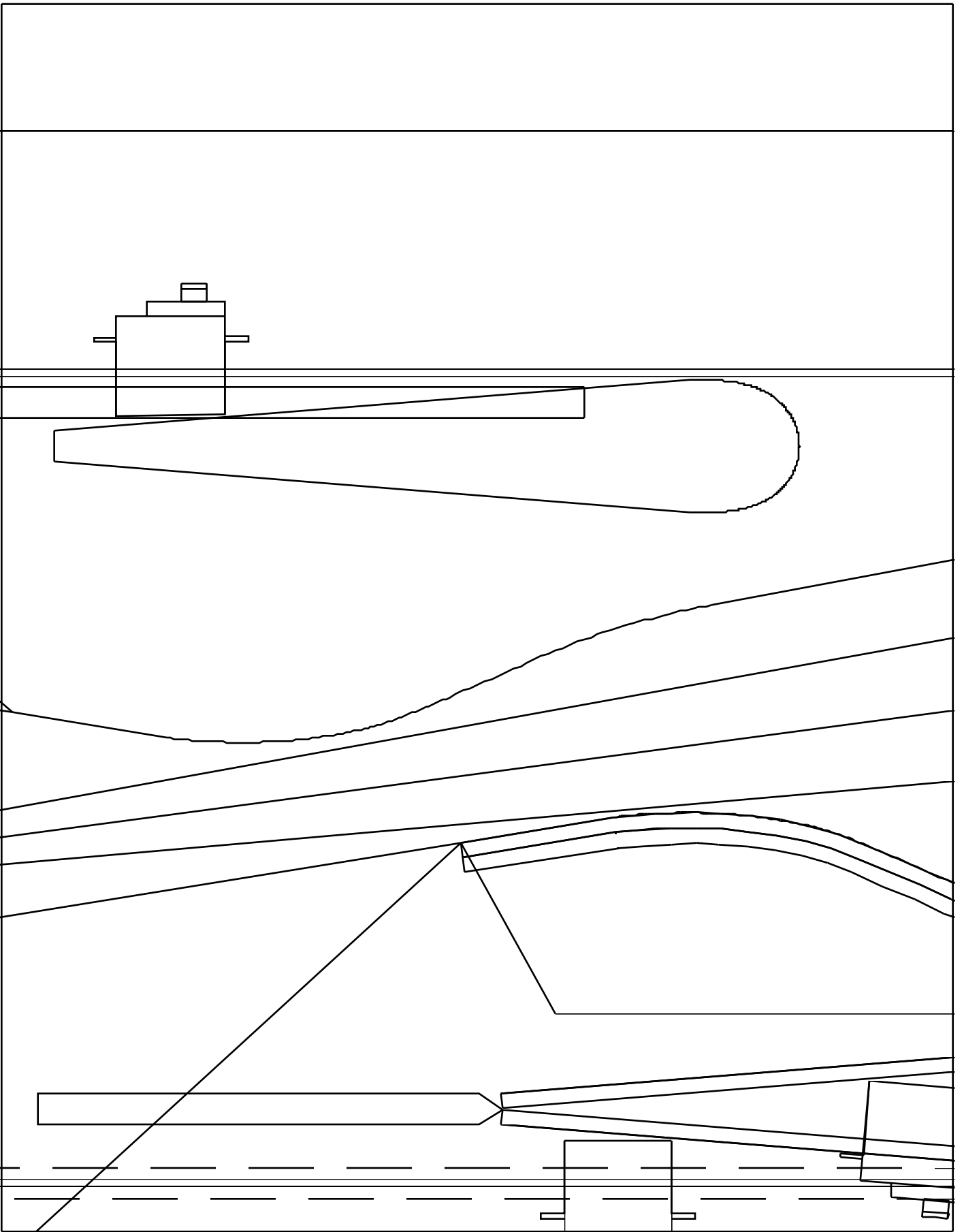

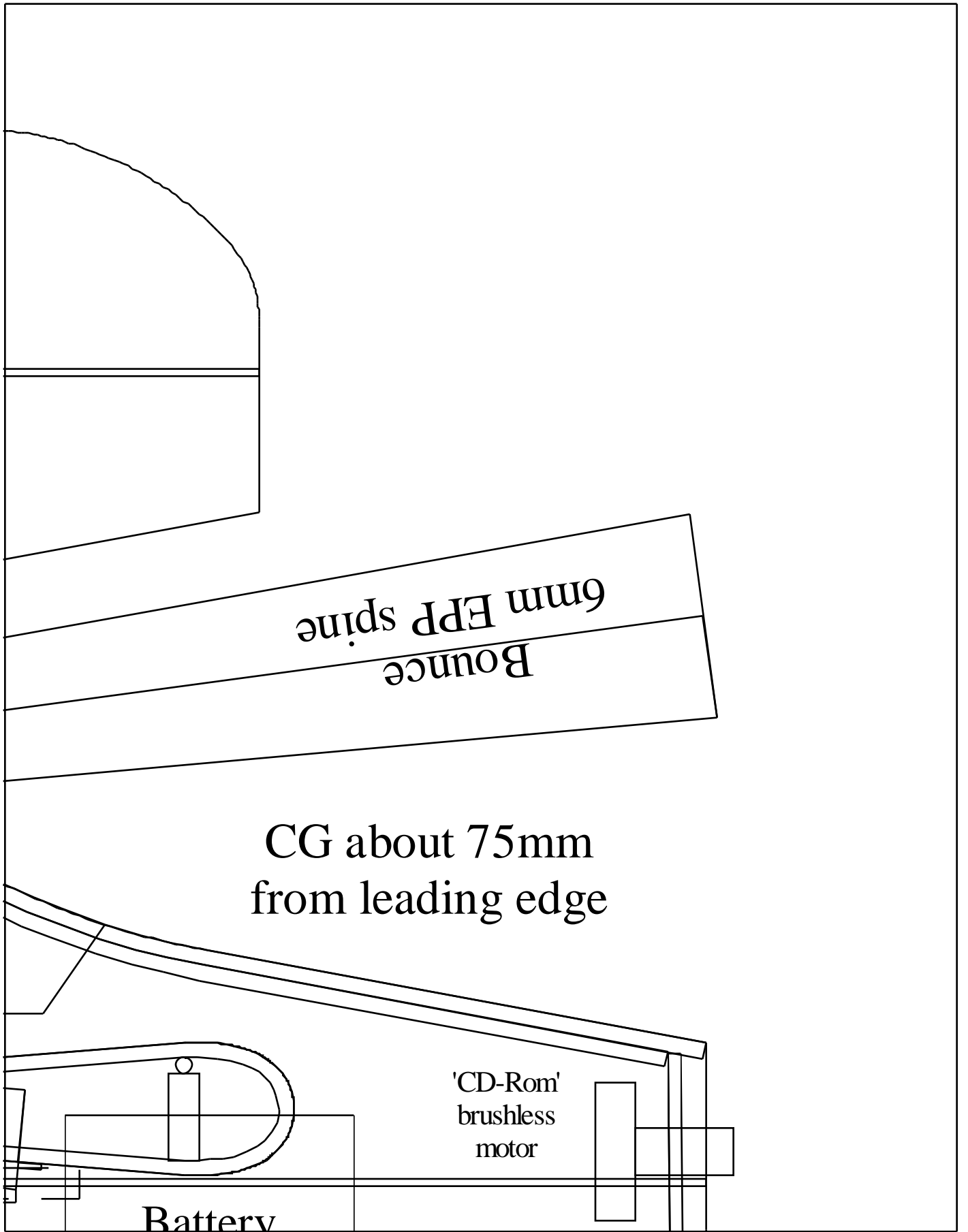

6mm EPP spine
Bounce

CG about 75mm
from leading edge

'CD-Rom'
brushless
motor

Battery