

100mm

200mm

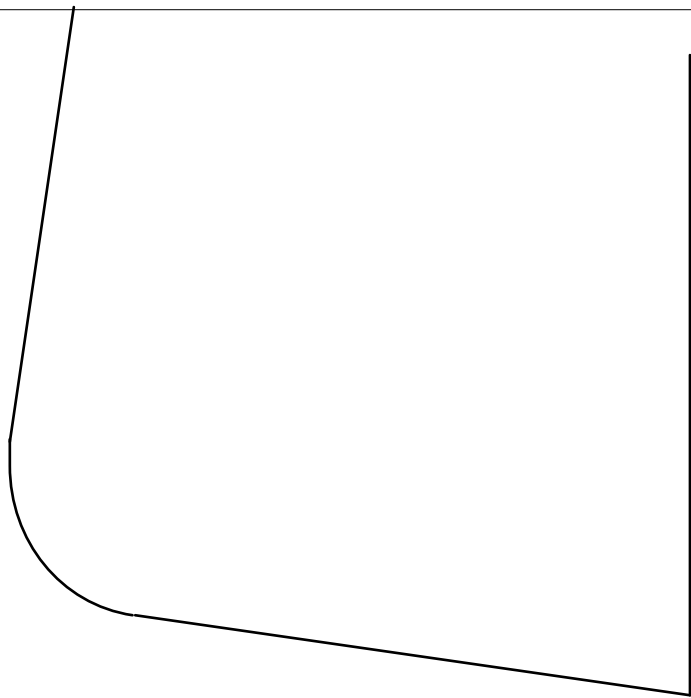
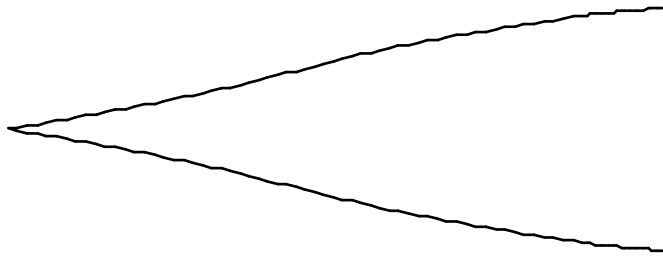

each
side

Bounce
6mm EPP Stab

Bounce
3mm EPP top doubler

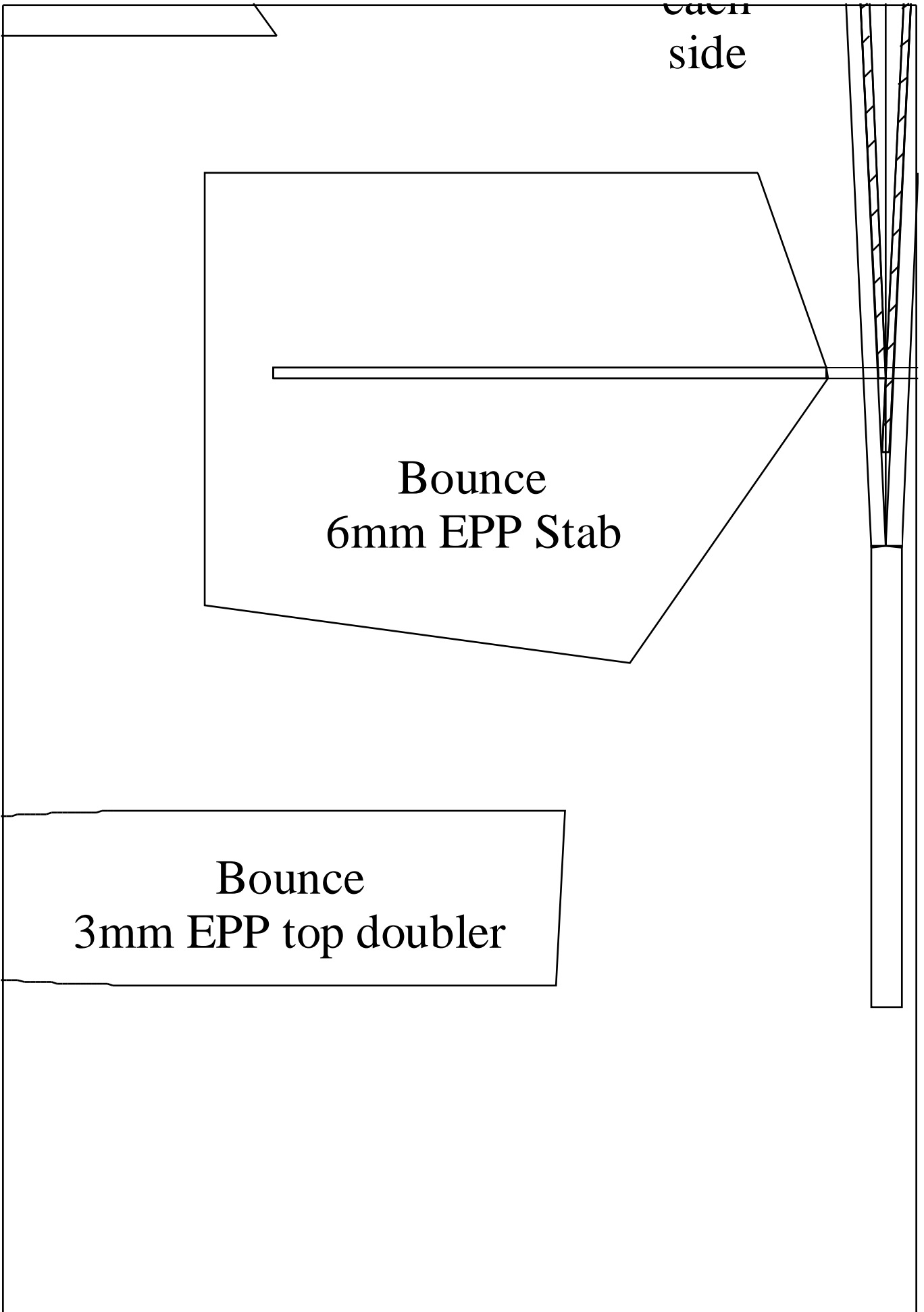

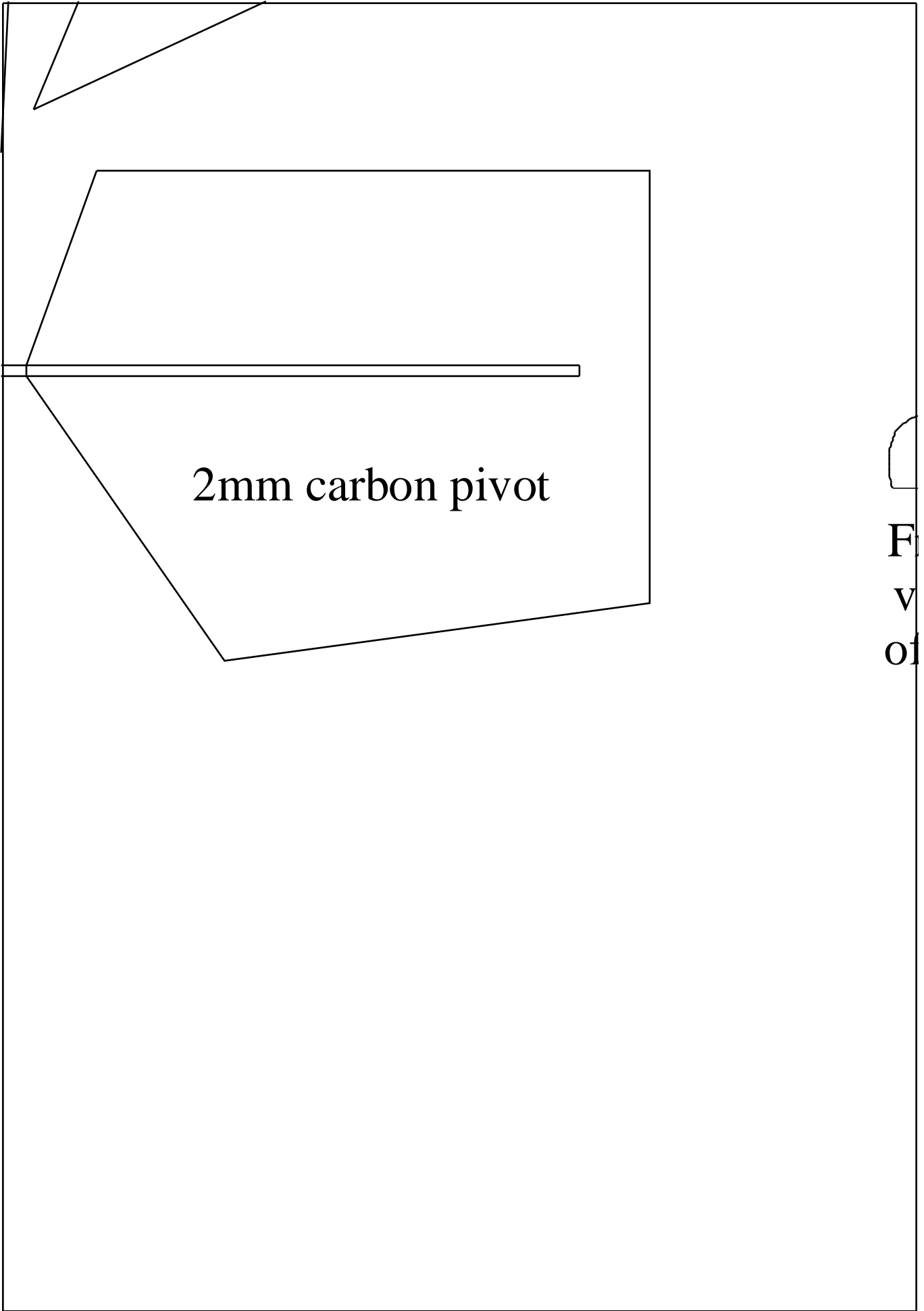

2mm carbon pivot

Front view of

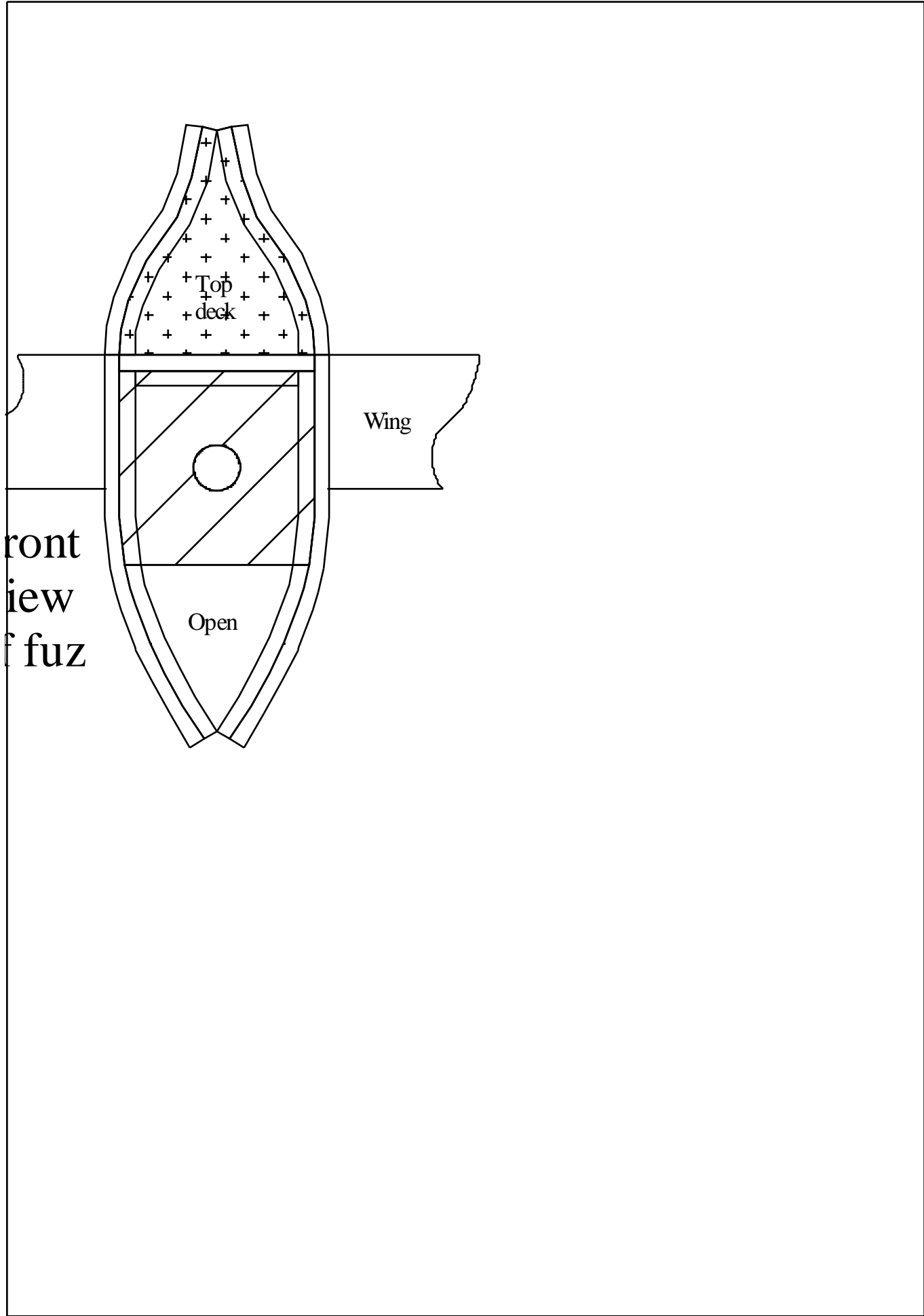

Top
deck

Wing

Open

front
view
of fuz

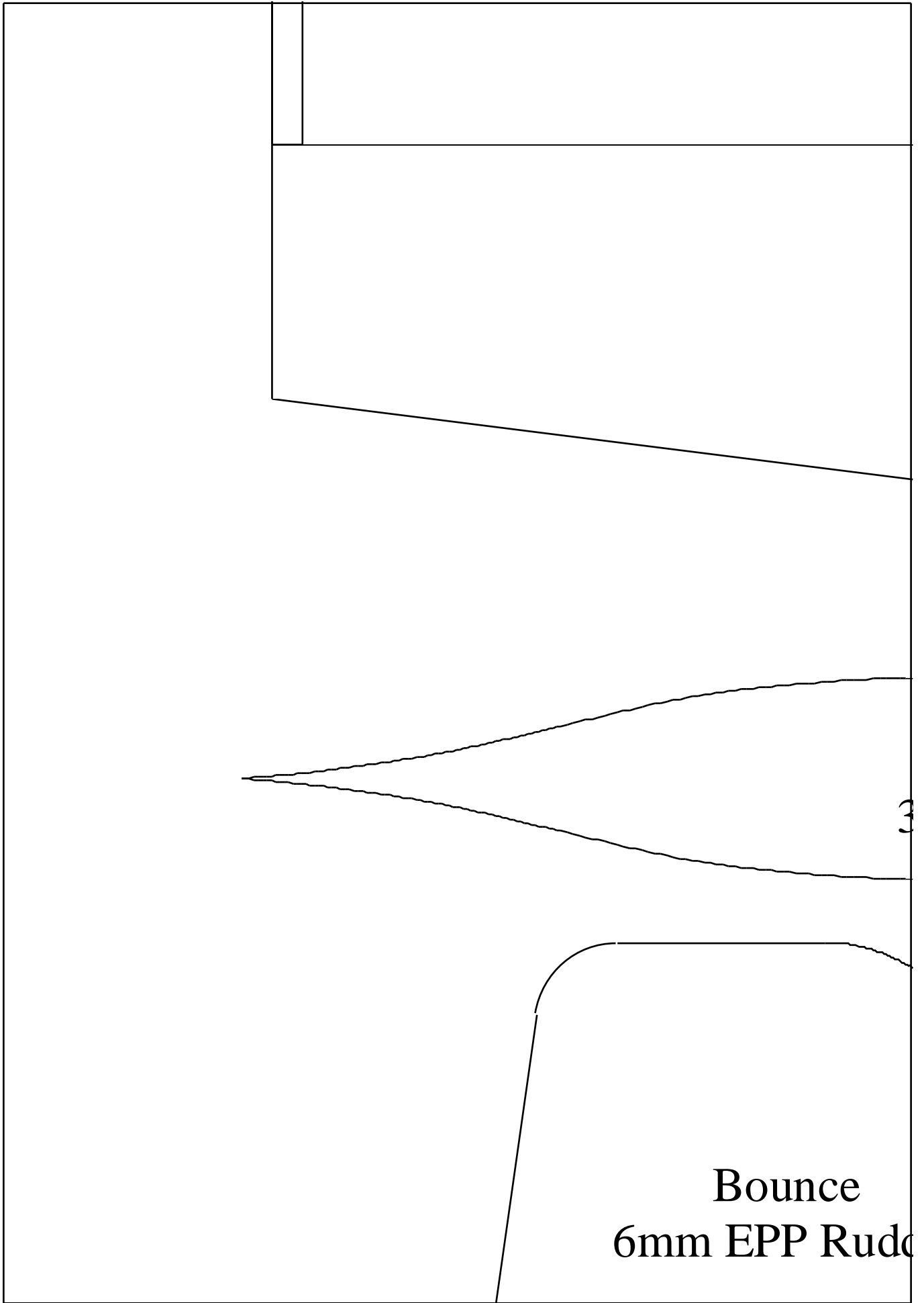

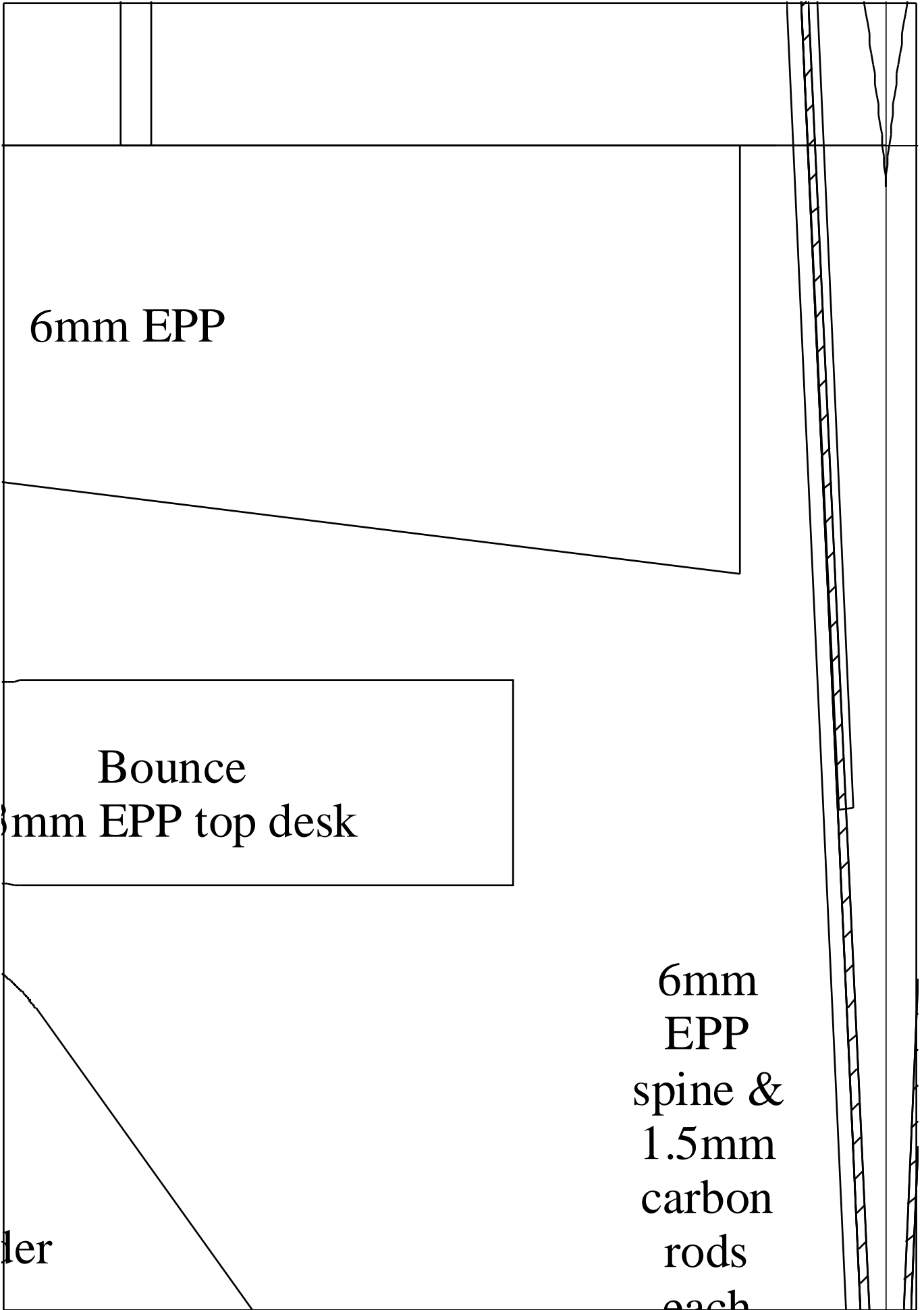

6mm EPP

Bounce

6mm EPP top desk

6mm
EPP
spine &
1.5mm
carbon
rods
each

ler

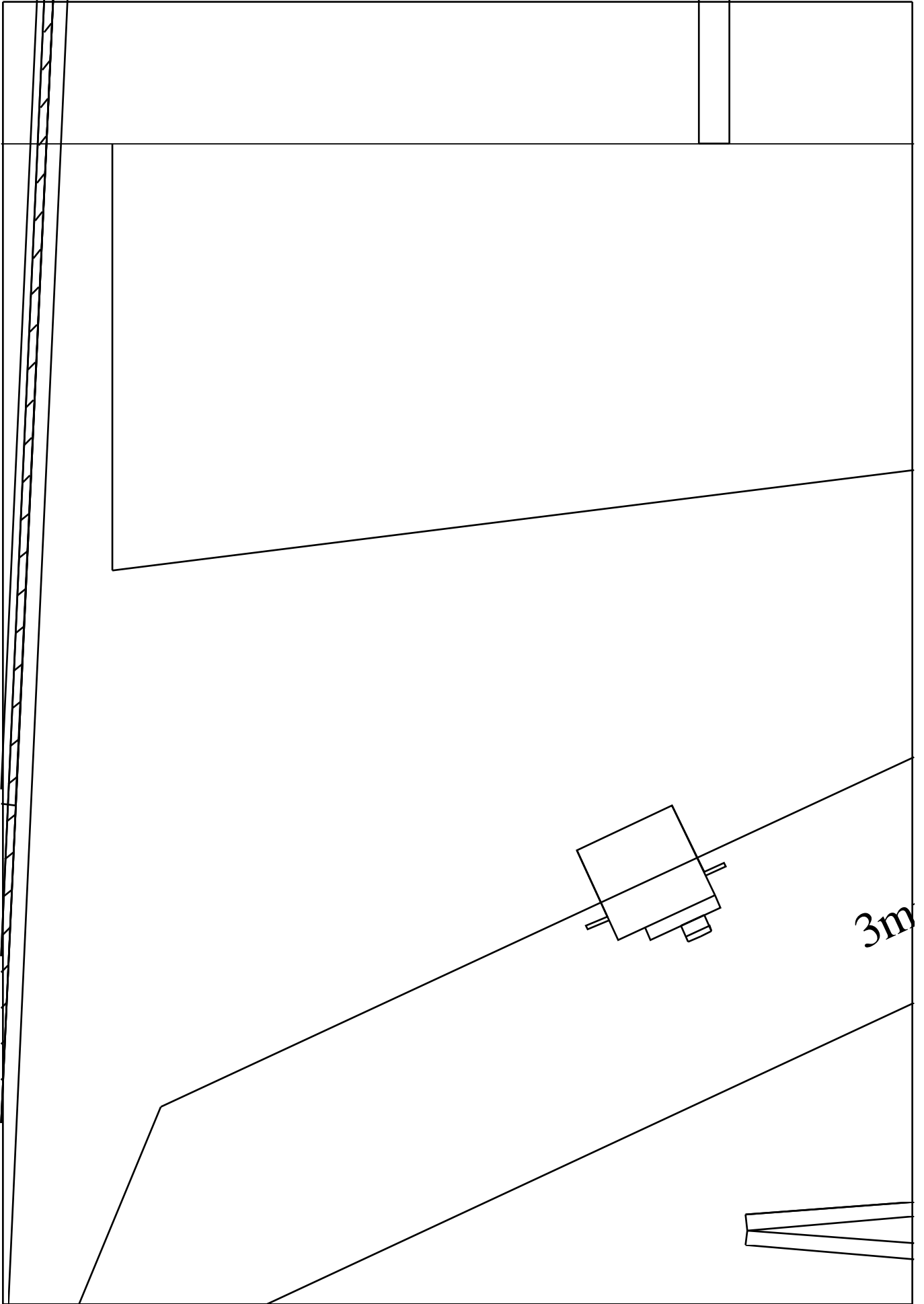

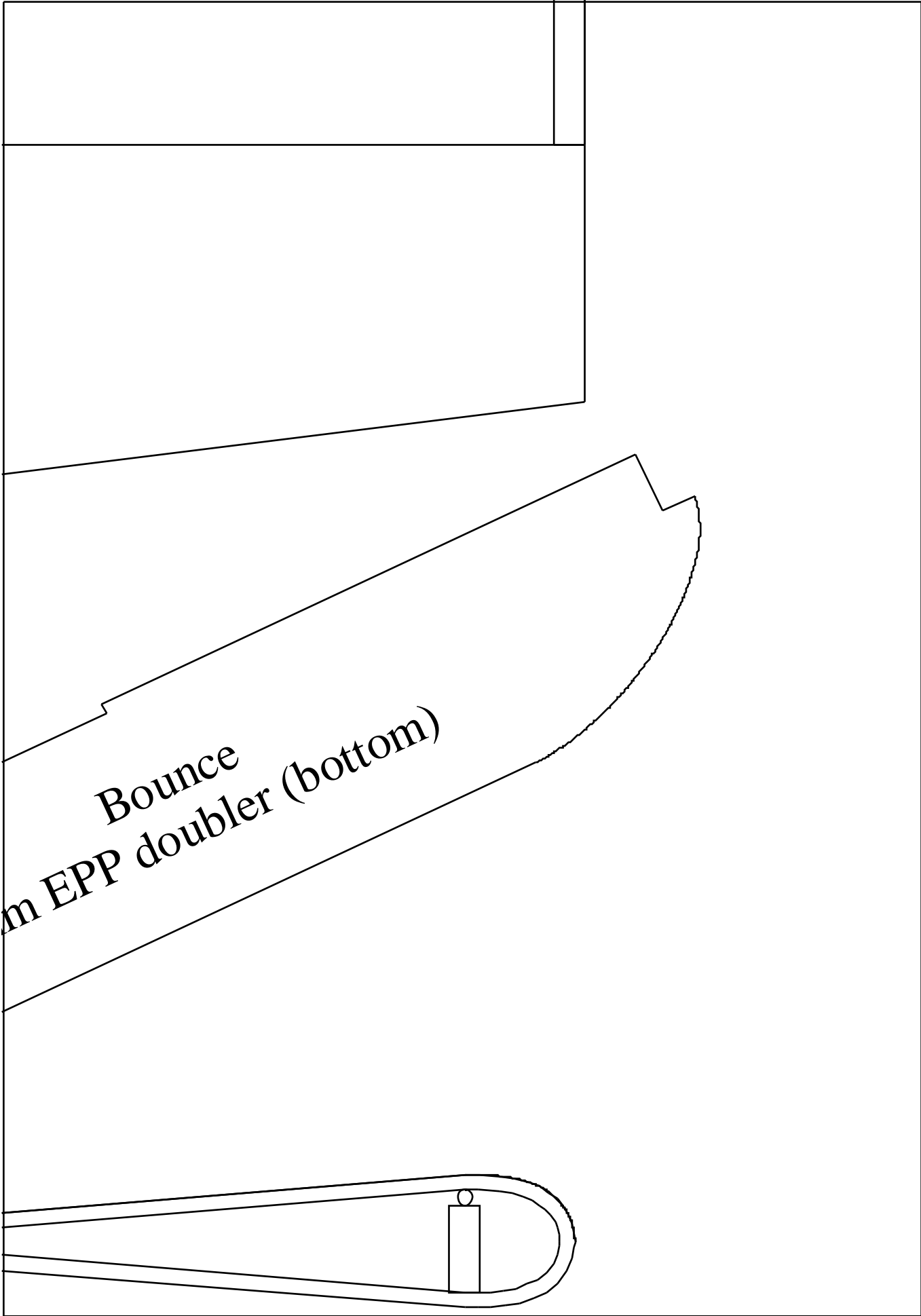

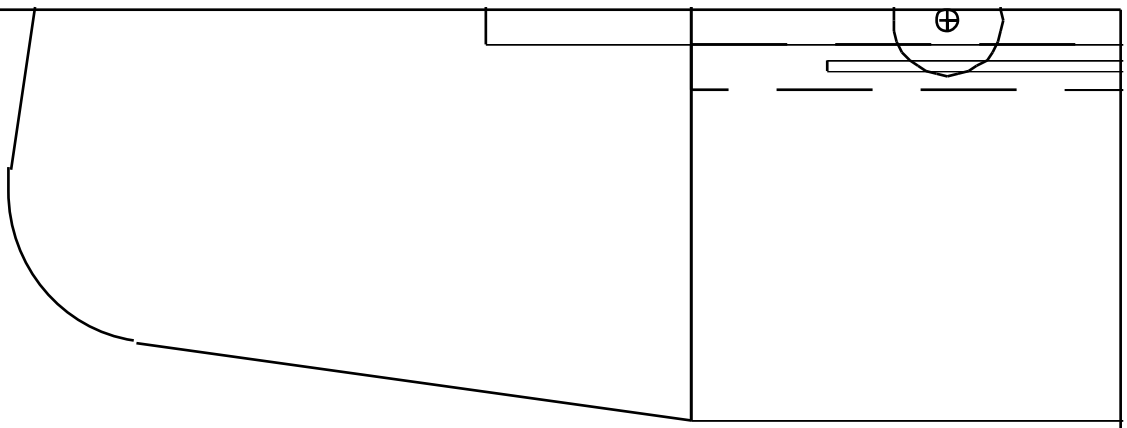

'Bound
Copyright Dav
5-Dec-05 www.flyele.com

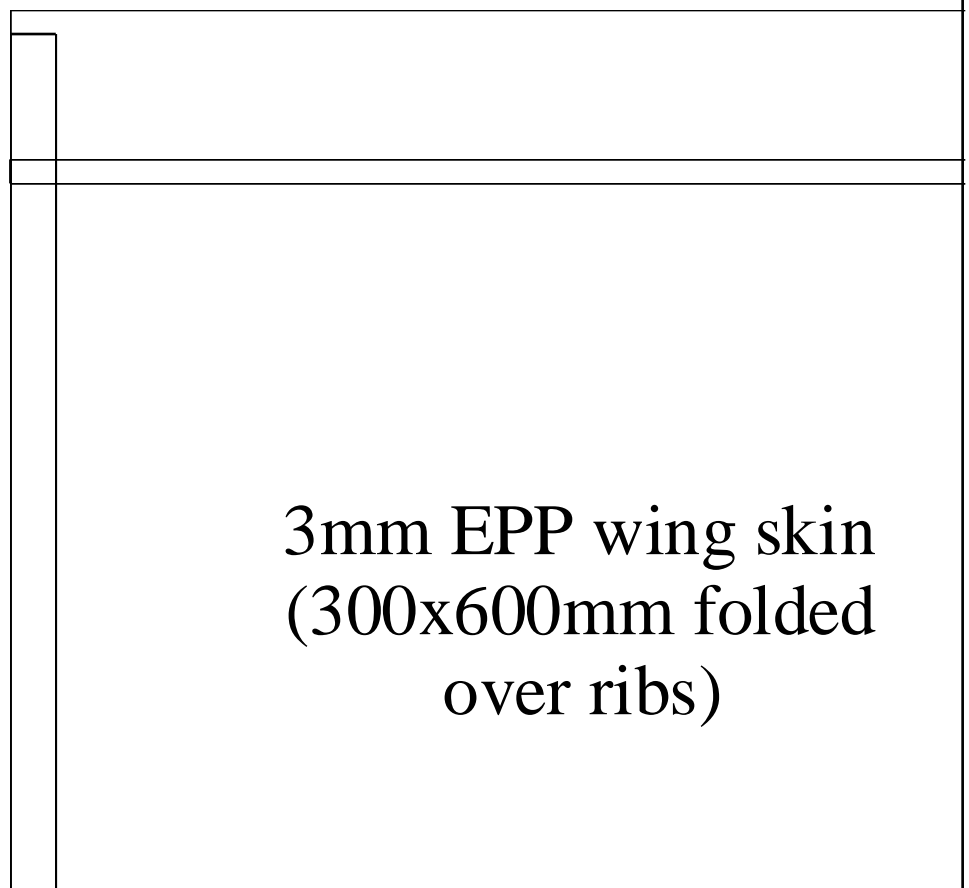

3mm EPP wing skin
(300x600mm folded
over ribs)

Horizontal 6mm EPP spine &
1.5 or 2mm carbon both sides

e' v4b
id Theunissen
ectric.ukgateway.net

CG
30-33%

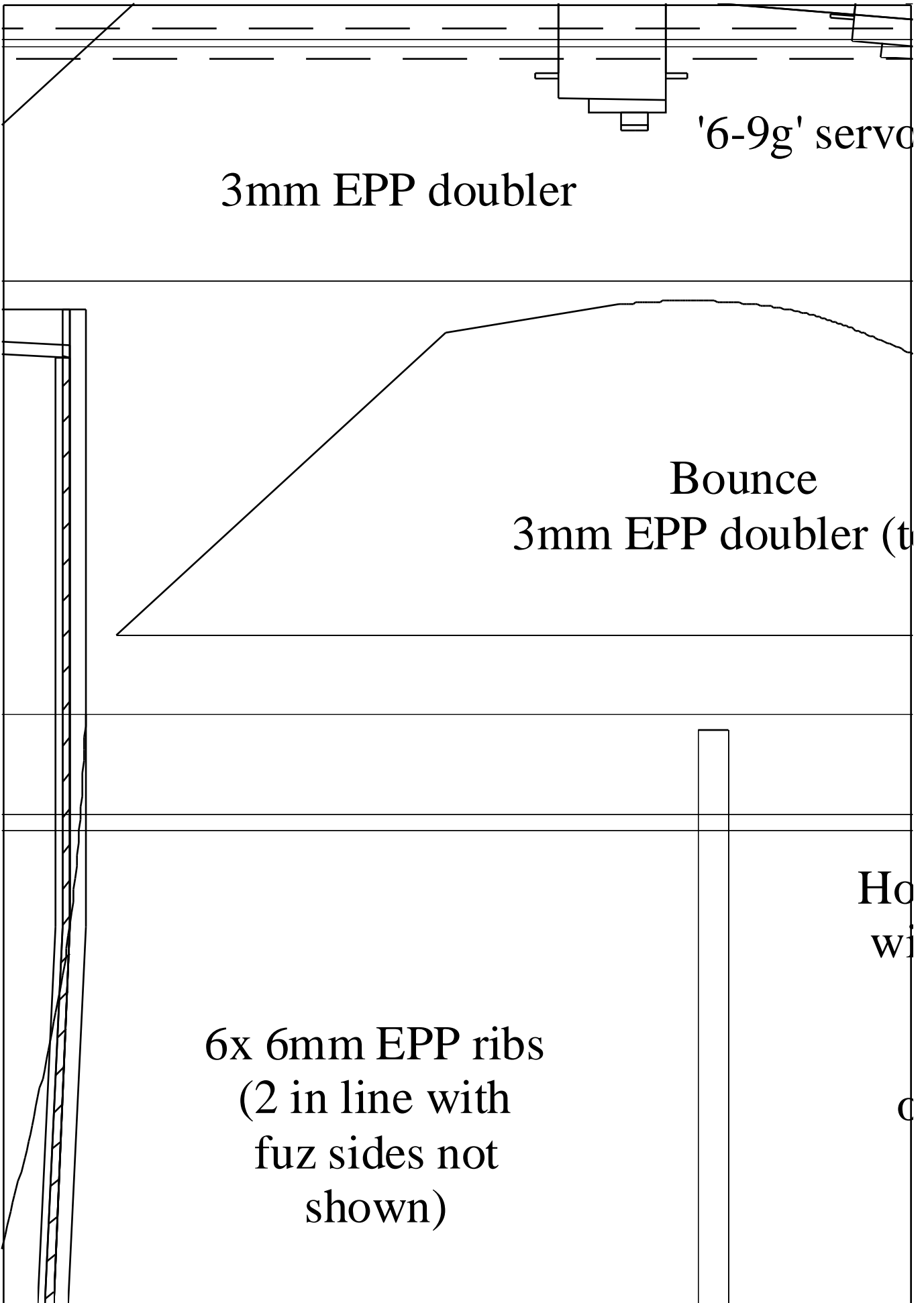

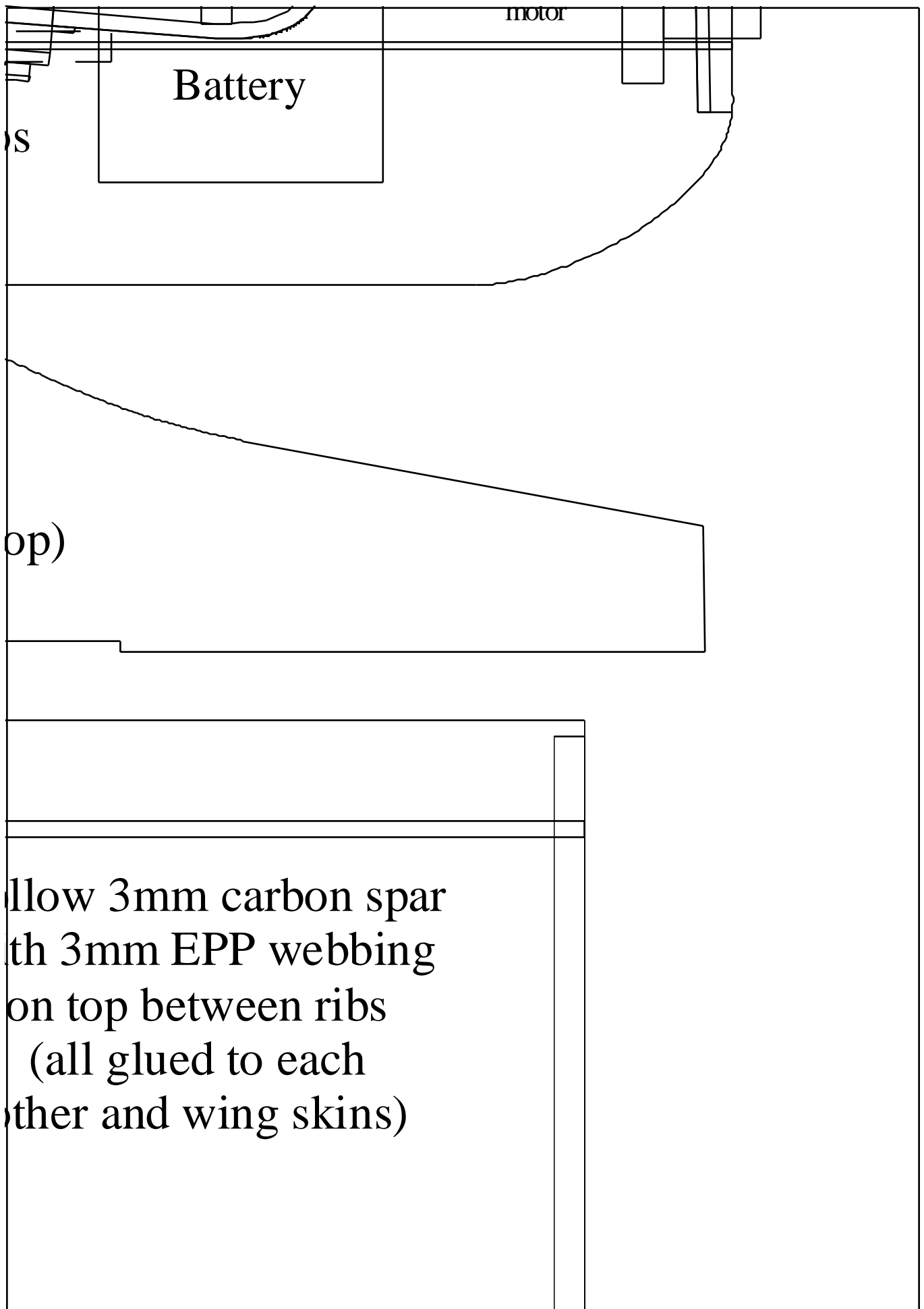

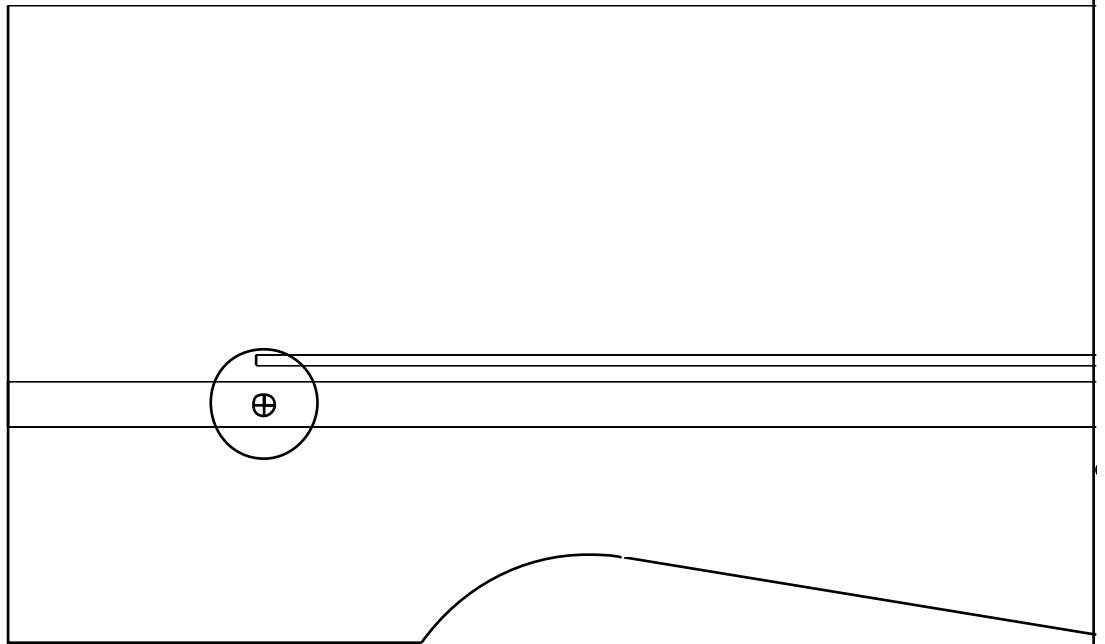

6mm EPP
Rudder &
Stabilisers

1/64" ply disc
each side

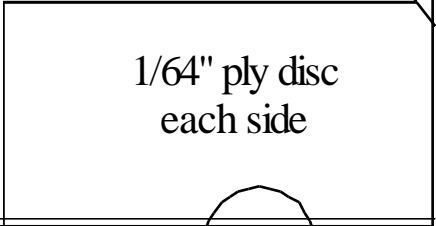

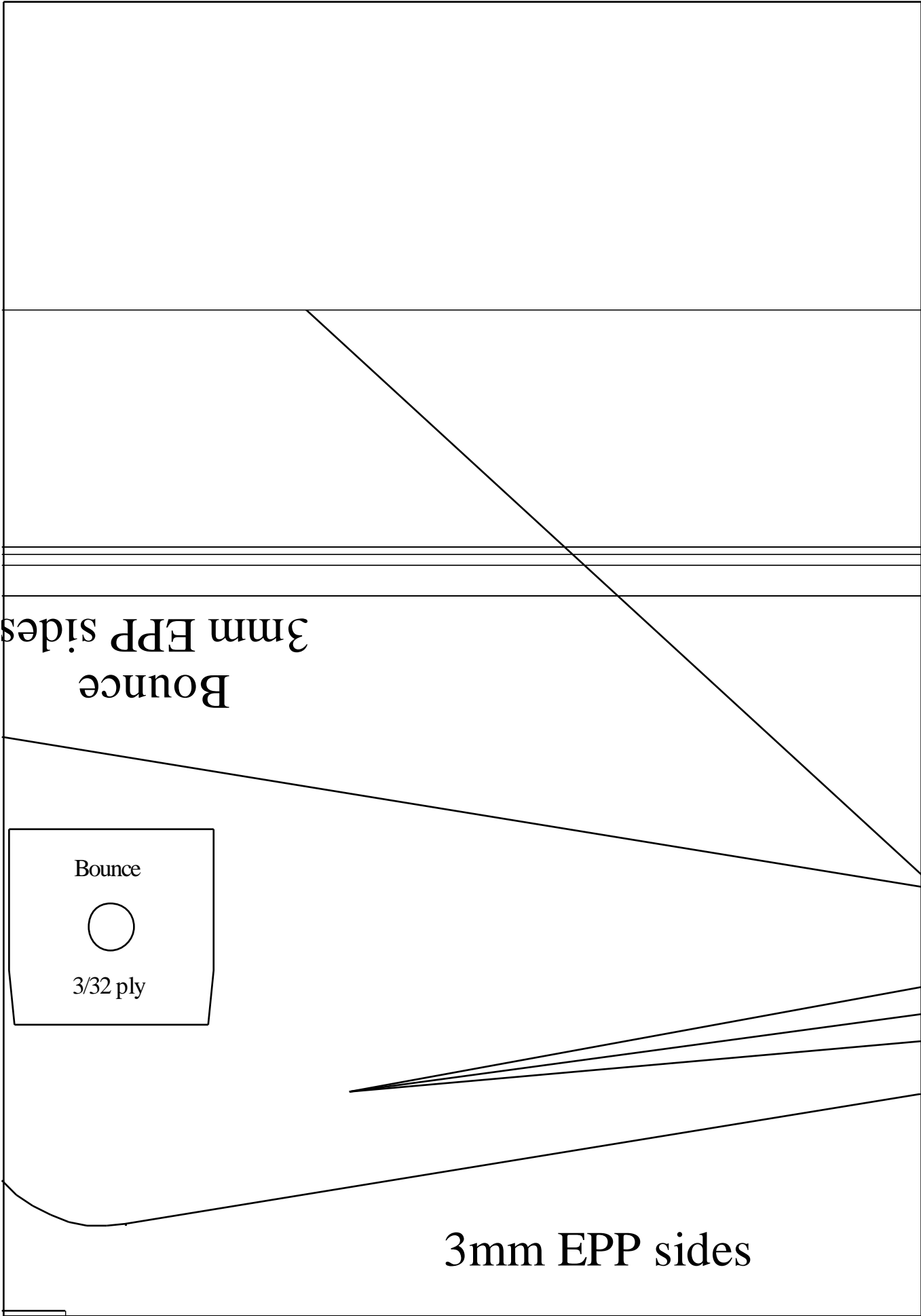

Bounce



3/32 ply

3mm EPP sides

